

Carolina



Carolina



Comfort

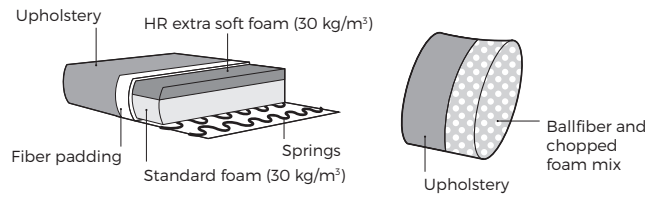

1. Upholstery



* Leather covers may require more stitches than fabric covers.

2. Armrests

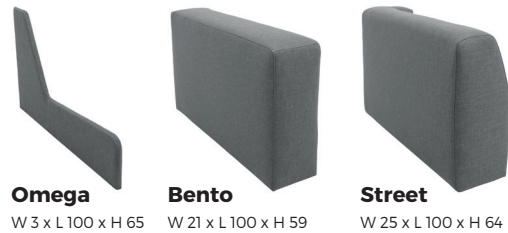

3. Choose pillows



Pillow **B** (85x52)

Pillow **P** (55x55)

4. Legs

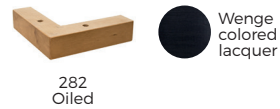

IMPORTANT:

Upholstered furniture is handmade using soft materials therefore measurements may vary up to +/- 5 cm.
Parts and sets shown in 2D drawings are left-sided. Parts and sets can be mirrored from left to right.

Single parts

Scale 1:100

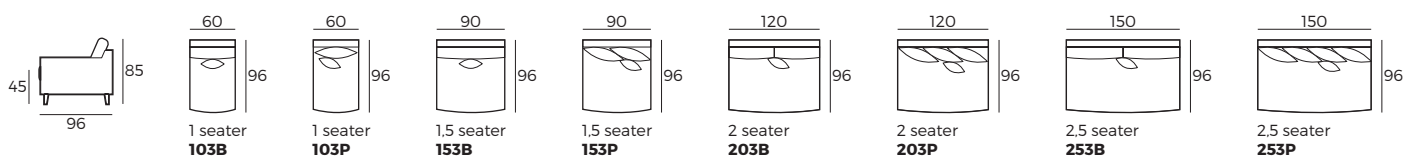

CUSTOM MADE COMFORT

Carolina

Scale 1:100

Single parts

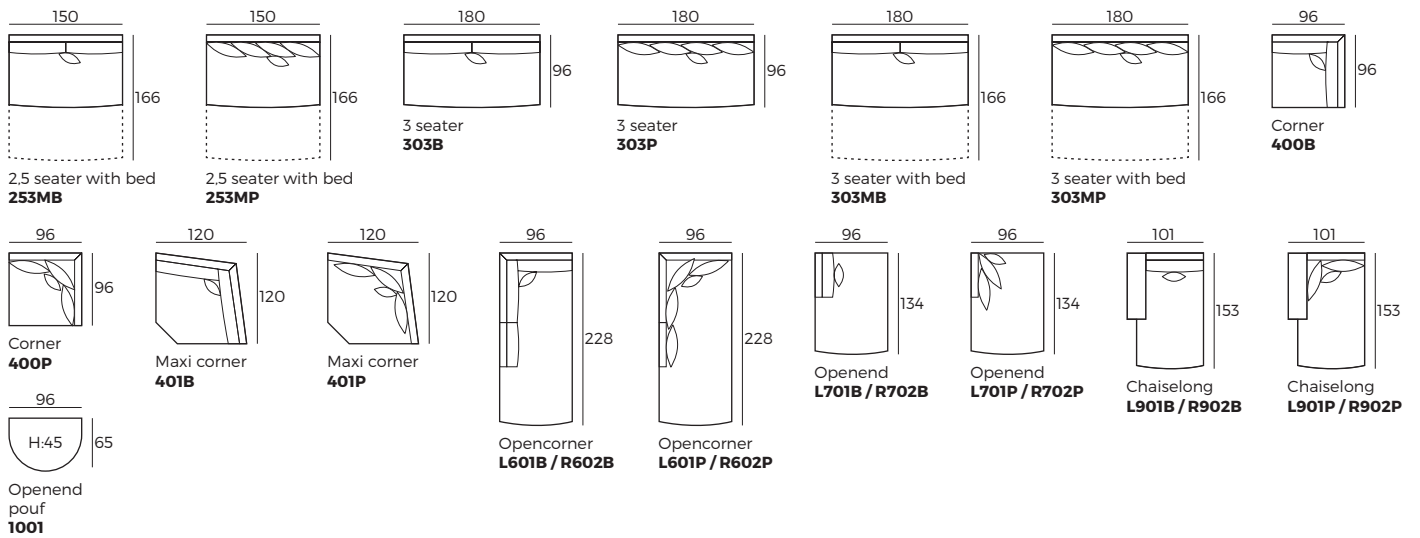

Half sets

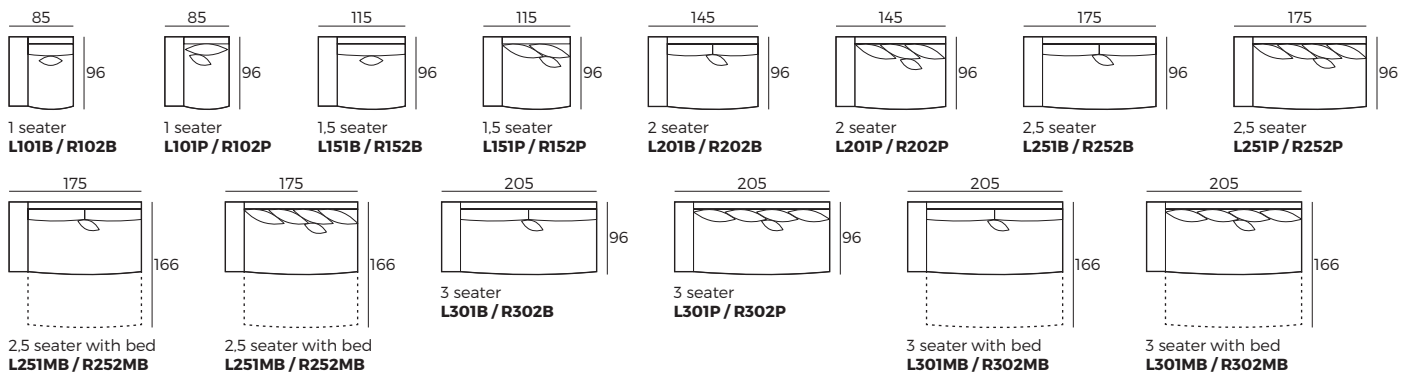

Sets

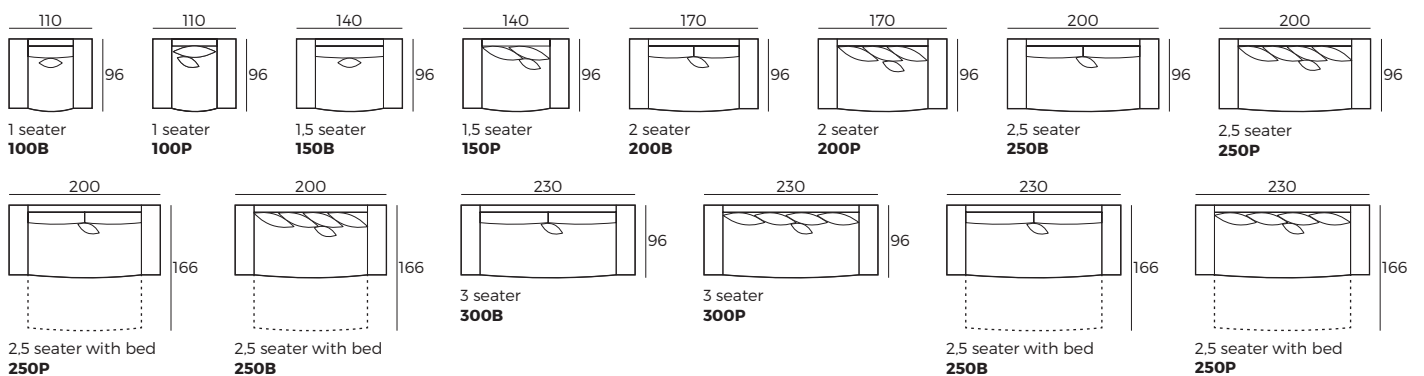

Accessories

